



Government of Nepal
National Reconstruction Authority
Singhadurbar, Kathmandu



**Strategic Paper on Private Housing
Retrofitting after
Post 2015 Gorkha Earthquake**

Contents

Introduction	1
Principles and strategies for retrofitting.....	2
Seismic retrofitting as post disaster housing as well as preventative measure	2
Key elements of a successful retrofit program	3
Actors in a retrofit program	3
Housing typologies typical to the earthquake affected areas of Nepal	4
Retrofitting approaches	6
Strongback approach:	6
GI Welded Wire Mesh Splint and Bandage (with Local Failure Jacketing) Approach:.....	9
Containment Reinforcement integrated Splint and Bandage technology	15
Retrofitting of timber houses:	18
Design guidelines and technical manuals	19
Seismic Retrofitting Guidelines of Buildings in Nepal.....	19
Repair and Retrofit Manual for Masonry Structures	20
Repair and Retrofit manual for RCC structures	20
Engineering manual: Standard Type Design Retrofits of Stone Masonry with Mud Mortar (SMM).....	21
Draft Norms for Rate Analysis of Retrofitting Masonry Building.....	21
Public outreach, information and awareness.....	22
Capacity building.....	25
Builder trainings – 50-day OJT for strong back approach.....	25
Builder trainings – 5-day OJT for CR integrated splint and bandage approach.....	25
Builders training – 25 days OJT for splint and bandage approach.....	26
Engineers training – competency-based OJT for strong back approach and splint and bandage approach	26
Engineers trainings – 4-day OJT for CR integrated splint and bandage approach.....	27
Engineer trainings – 4-day classroom training including site visits	27
Engineers and Sub engineers Training – 4-day on Inspection Training for Retrofitting	28
Engineers Training – 5-day on Masonry Retrofit Design Training	28
Stock taking.....	29
Study on Retrofitting in the Urban Areas	31
The qualitative and quantitative approach.....	31
Challenges and learnings on retrofitting	34
Way forward:	35

Introduction

In Nepal, there is currently a stock of around 6 million houses across the whole country and 2.5 million houses in the 32 districts affected by 2015 earthquake. About 800,000 houses are categorized as reconstruction beneficiaries whereas approximately 70,000 are categorized as retrofitting beneficiaries. Analysis suggests that there remains almost 3.5 million houses nationwide and up to 1.1 million houses within earthquake affected districts that require seismic retrofitting in some form.

Retrofitting is the judicious modification of the strength, stiffness and ductility of structural members or of the structural system to improve the structure's performance in future earthquakes. Retrofitting generally includes increasing the strength or ductility of individual members or introducing new structural elements to significantly increase the lateral force resistance of the structure. There are several approaches and techniques for the retrofitting of existing buildings currently in application all over the world. In low strength masonry buildings, especially in stone and mud masonry, however, due to limited implementation examples, repair and retrofitting is viewed as an unfeasible option by our communities. That is why, many earthquake affected house owners have opted towards demolition of their damaged houses for reconstruction rather than retrofitting. While retrofitting also presents an ideal means for the conservation of traditional architectural heritage and provides the required space for beneficiaries to maintain their traditional agrarian lifestyle.

However, Nepal has a long experience of seismic retrofitting. About 300 schools were retrofitted in Nepal before 2015 Earthquake and all of them performed excellently during Gorkha Earthquake. There were cases where a weak Brick in Mud block retrofitted prior to earthquake stood without a crack whereas in the same premises, a Reinforced Concrete building, which was believed to be relatively strong, collapsed. Those examples and experiences were mainly on brick buildings and there were only few examples for retrofitting of stone in mud buildings before earthquake and also those were only for school buildings. According to the data obtained by the Central Bureau of Statistics in Nepal, more than 74% of the buildings damaged in the Gorkha earthquake was of low strength masonry typical in rural Nepal, emphasizing the urgent need for retrofitting of similar houses spread across.

Despite more than 18 years of experiences of retrofitting preceding the earthquake; very limited guidelines and manuals related to retrofitting were available and the knowledge was within limited organizations and professionals. Retrofitting was not a common practice among the masons and engineers compared to the new construction practices. This was more so evident in rural area of Nepal for typologies such as Stone in Mud masonry houses.

While retrofitting was undertaken in a relatively small-scale intervention compared to new construction post 2015 earthquake, it was an important intervention that has paved the way for risk reduction and mitigation against future possible disaster. A number of retrofitting resources has been developed by the government and various organizations, and lessons learnt during implementation of retrofit programs has been recorded. These are valuable learnings and documentations that should guide any future implementations of retrofit programs or projects.

Many technical resources like Retrofit manuals, guidelines, innovative retrofitting approaches, mason training guidelines, engineer's trainings, on the job trainings, etc. were produced by implementing partners. Numerous technical and non-technical papers were presented and published in numerous national as well as international platforms. Non-technical, awareness generating, sensitizing efforts were carried out, for which many IEC materials, video documentaries, PSAs, etc. were also developed. It is important that these information are compiled, documented and readily available for future use.

The list of all the documents collected during the documentation process is available in Annex 1. Digital copies of these documents can be accessed through the link provided in the Annex.

Principles and strategies for retrofitting

Post-disaster seismic retrofit of housing presents an opportunity not only to ensure safety of the affected population but also to change construction practice permanently so that local builders, engineers, and homeowners build safe houses in the future. Some of the strategies and considerations that were adopted to design or choose appropriate retrofitting approach are as follows:

- Promotion of appropriate technologies that technically reliable, economically affordable, locally available, socially acceptable, sustainable and environment friendly.
- Use of detailed housing subsector studies to determine the most cost-effective ways of retrofitting houses using materials and skills that are available through the local private sector.
- Leverage the knowledge and skills of the technologies used in the region while taking into consideration local sustainability and acceptance.
- Empower the homeowners to participate in the design and manage their own construction, with technical assistance.
- Build local knowledge and capacity by working with engineers and architects, builders, universities and government.
- Work with local masons, carpenters and homeowners through on-the-job trainings to build their confidence and capacity to incorporate disaster resistant building techniques that are culturally accepted and easy to adopt with limited training and education.
- Build confidence of all actors, particularly policy makers through sensitization, demonstration and pilot programs.

Seismic retrofitting as post disaster housing as well as preventative measure

A seismic retrofit program addresses risk to existing houses, hence the homeowner should have sufficient awareness on the risk itself to assure his/her buy-in for the plan. A retrofit is cheaper than new construction and less time consuming. Hence an early retrofit program can add quickly to the stock of safe housing. Advantages of seismic retrofitting as post disaster intervention as well as preventative measure are:

- Buildings are strengthened to a better level of seismic performance, ensuring life safety.
- Engineers and builders are trained to design, and construct retrofit solutions which could be new skills for many.
- Promotes an understanding of the key weak points in the existing and prevalent construction practice that led to the damage in the first place.
- Skills for retrofitting, which is usually not a traditional practice, will be retained in the community and will be used in future by local engineers, builders and homeowners.
- Traditional aesthetics of the house is maintained.
- Families are displaced for much less time while their houses are being retrofitted than with new construction. Land ownership issues do not arise.
- Cost of retrofitting is significantly cheaper in terms of materials and labor than new construction
- A retrofit program can be started early in the relief process, hence, the money that would otherwise be used in temporary solutions can instead be used for retrofitting.
- A post disaster retrofit program can aid in transfer of skills to builders, engineers and material producers which paves the ways for promoting retrofitting as a preventative measure in future.

However, the design cost may be significant as different houses might need to be treated uniquely, if not covered by ready to use retrofit manuals and type designs. In such cases, an experienced structural engineer might need to be employed, which can prove to be expensive and inaccessible for homeowners living in remote villages. Hence, a guideline as MRT could be helpful.

Key elements of a successful retrofit program

- A homeowner driven retrofit program is most effective when the essential technical, financial, and social components are in place.
- Retrofitting will become more effective only if the technology is locally available, widely known and culturally accepted.
- Homeowners should have been well sensitized on the importance of safety for them to be willing to invest their savings on upgrading the safety of their house despite the fact that they might not gain additional living space.
- The materials used for retrofitting should be easily available in local markets and skills to work on these materials need to be present in the community.
- Demand for safe housing must be created among homeowners through information campaigns and coupling financing with building standard compliance.
- People from different cultures have their own ideas about what a house should be. They will accept structural requirements if their ideas about layout of interior and exterior spaces, orientation to light/wind/view/privacy and security are respected.
- Incentives from the government for retrofitting their houses should be in place to motivate the first lot of homeowners in the community to retrofit.
- The availability of locally trained human resources like masons and engineers should be ensured and to be easily accessible to the house owners, who can provide technical guidance and execute the work with use of local materials and technologies.
- Care needs to be taken that a condition where retrofitting is labeled as a poor persons choice should not arise.

Actors in a retrofit program

Invaluable lessons are learnt in the field, both individually and institutionally about constructability and general feasibility of various design solutions. A feedback loop should be put in place such that a continuous learning process exists, constantly improving evaluation, design and construction processes. This can happen if there exists good coordination between different actors in the system. There are a number of stakeholders involved in post-earthquake housing retrofit. Major stakeholders and their functions are as follows:

Government	Homeowners	Community Groups	Partners
<ul style="list-style-type: none"> • Develop policies and plans for promoting retrofitting, its enforcements and quality assurance. • Providing incentives to homeowners or community group for retrofitting and also oversee the work of the implementing partner. • Produce or adopt codal guidance or design guidelines for retrofitting. • Review designs, provide permit and conduct inspections to ensure compliance with approved construction documents. 	<ul style="list-style-type: none"> • Lead the process including design, resource management, implementation and maintenance. • Hire trained and certified builders and oversee construction. • Arrange for materials and labour and any additional costs to be incurred in retrofitting. 	<ul style="list-style-type: none"> • Assist in public awareness outreach campaigns • Provide support, <i>arma-parma</i>, to the house owners, supporting retrofitting • Identify local builders, building materials suppliers and other stakeholders 	<ul style="list-style-type: none"> • Liaise with community groups and local government to implement awareness building and outreach activities • Provide technical assistance to homeowners for design, trained masons selection and construction process • Capacity building of local builders, local engineers and architects on retrofitting • Support in producing technical resources for retrofitting

Housing typologies typical to the earthquake affected areas of Nepal

There are many different housing typologies in different parts of Nepal. Stone masonry in mud mortar buildings is the typology on which most of the retrofitting initiatives have been focused. However, this section enlists only major typologies relevant to the post-disaster reconstruction and retrofitting.

Stone masonry in mud mortar (SMM) houses

Typical SMM houses are between one and 2.5 storeys in height (two storeys plus attic) with a pitched roof. On plan, they are typically between 8m and 11m in length, and 4m-6.0m in breadth. The typical storey height is approximately 2.1m for the ground and first floors, and upto 1.2m for the attic. The walls are at least 450mm thick. Most of these houses do not have cross walls. On the first floor it is typical for two rooms to be divided with the help of plywood partition walls on either side of the staircase. The performance of SMM walls will depend on their geometry (height and thickness), and the quality of masonry. Better quality walls contain a low ratio of mud to stones, more regular sized and shaped stones, and many through stones. In a traditional SMM house, the ground floor is typically used for livestock, the first floor for sleeping and the attic floor for the kitchen and food storage.



Figure 1: Typical 2.5 storey SMM building



Figure 2: Ground floor room of SMM building

The thick SMM load bearing walls are typically composed of two faces of placed stone with a rubble filling in the centre of the wall cavity. The timber floor consists of joists supported at one end on the longitudinal SMM walls and the other a central longitudinal timber girder. The joists are normally well embedded into the walls. The timber girder is supported on timber posts and typically embedded into the transverse end walls. Typically, a house has four posts supporting the middle girder – one at each end and two in the middle. These wooden posts occur at each floor in approximately the same location, ultimately supporting the ridge beam of the roof. The transverse wall is usually connected to the floor framing only through this middle girder.

Stone masonry in cement mortar buildings

These are relatively newer building typology, constructed after cement started becoming available in rural parts of Nepal. Before the earthquake, many public buildings were made of stone in cement mortar, which have also been adopted in construction of the houses. The floor is usually made of reinforced concrete slab but in some cases made out of timber joist with a plank floor. The roof are typically two-way slope and the outlooks is usually similar to the SMM buildings.

Brick Masonry in Mud Mortar buildings

These are houses typical to old settlements in and around Kathmandu Valley. These comprise of load bearing masonry walls made of bricks with mud mortar. The floor is made of timber joist and wooden planking with mud floor overlay. These houses can be up to four storeys high with typically low storey heights.



Figure 3: Typical brick in mud mortar house

Brick Masonry in Cement Mortar buildings

These houses are found in relatively newer settlements in and around Kathmandu valley. These comprise of load bearing masonry walls made of brick units joined with cement mortar. The floor is usually made of reinforced concrete slab but in some cases made out of timber joist with a plank floor.



Figure 4: Typical brick in cement mortar house

Timber buildings

In some parts of Siwalik range, high use of wood in building construction is found. Wooden frame buildings are found to be constructed using traditional method in Sindhuli, Makwanpur and Okhaldhunga district. The two types of timber buildings that are common in these area were retrofitted. That are as follows:

Bare timber frame: Unbraced timber frames with timber plank walls. These are typically two stories high. During the retrofitting process, the bare frame is converted into braced frames by providing bracings and connection improvements of the timber structure. The bracings are designed to take all the lateral load due to earthquakes.



Figure 5: Typical timber framed house

Timber frame with masonry wall: These buildings have timber frame with masonry infill in the ground floor. Retrofitting is done to comply with requirements of Light timber and steel structures manual published by the GON. This consists of designing a timber bracing scheme considering lateral bracing capacity of masonry walls. Also, existing timber connections of roof, timber system and between two floors are improved. The stability of masonry wall is ensured to prevent overturning.



Figure 6: Typical timber frame building with masonry infill in ground floor

Reinforced concrete frame buildings with masonry infill

These buildings have a reinforced concrete beam and columns system. The frames are typically infilled with brick masonry in cement mortar. The masonry is typically constructed after the frames are erected and most of the times not connected to the frames.



Figure 7: Typical reinforced concrete frame building with masonry infill

Retrofitting approaches

There were various retrofitting approaches that were implemented by partner organizations during the reconstruction post disaster. Some of the approaches were based on the guidelines and manuals on retrofitting published by the Government whereas the others were based on new approaches developed by the partners with approval from CLPIU/NRA. The approaches that were used are defined in brief below:

Strongback approach:

The strong back approach is based on the type design approved by the Central Level Project Implementation Unit (CLPIU), Building division, under the National Reconstruction Authority (NRA) of Nepal. A manual aiding the use of the type design has been prepared by the UNOPs consortium and can be accessed from the list of resources in Annex.. This type design can be used by engineers.

The strong back design comprises a system of reinforced concrete strong backs placed at corners and at locations along the length of the wall, connected at the floor level by slab strips and ring beam at the top of the walls. The strong back is connected to the walls with the help of through anchors.

At the floor levels, a slab strip is provided around the inside perimeter of the wall and across, connecting opposite strong backs. A reinforced concrete ring beam is provided at the top of the walls to provide connectivity and restraint to the walls at the top.

Through concrete is provided all over the walls. The through concrete connects the inner and outer wythes of the thick walls preventing it from delamination and hence increasing the overall out of plane capacity of the walls.

Finally, a cement sand plaster is applied to the walls on the internal and external surfaces.

Heavy gable walls made of SMM is dismantled and a light CGI or timber gable is provided with good connection to the roof and the ring beam. In addition, improvements to the connections with the existing timber elements are provided with the help of CGI straps.

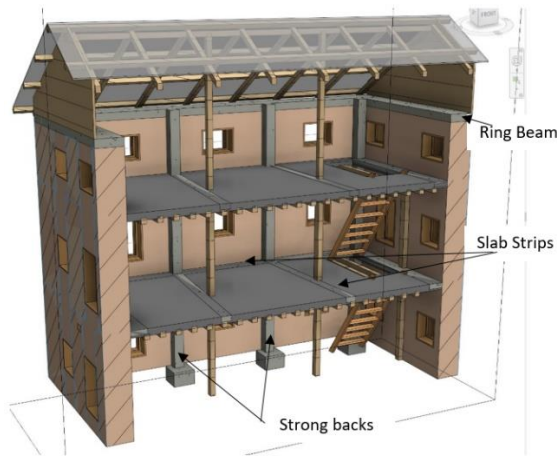

Figure 8: Schematic of strong back approach of retrofitting



Figure 9: House retrofitted using the strong back approach

Through Concrete - Through concrete is provided to bond the inside and the outside wythes of the SMM wall. Providing through bonding elements to interconnect the stones throughout the width of the wall helps to prevent delamination. A through bonding element of concrete and rebar is used as shown in Figure 10; these are effective as a secure bond to the existing stones can be created. The through concrete is approximately 150mm diameter. In the type design, these are placed at a spacing of 600mm center-to-center in horizontal and vertical directions along all walls.

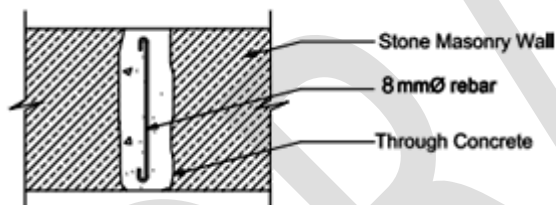

Figure 10: Through concrete in an existing SMM wall

Ring Beam - In order to facilitate connection between the walls, and to ensure the attic walls are adequately braced out-of-plane, the retrofit design calls for a new reinforced concrete ring beam at the top of attic wall, below the roof, as shown in Figure 8. The ring beam connects the walls together and promotes a box effect. The ring beam in the type design is directly connected with dowels to the new strong backs.

Strong Backs - Vertical strong backs are attached to each wall pier and connected to the slab strips at each diaphragm level and ultimately to the ring beam at the top of the walls. The function of the strong back is to brace the walls out of plane and provide a load path for the out of plane wall loads to reach the diaphragms above and below. The strong backs also acts as a buttress to break the horizontal span of the wall. These members are designed with the intention of carrying seismic out-of-plane loads from the walls to the levels above and below. They are connected to the masonry walls at two equally spaced points between each floor level by rebar dowels that are grouted into the wall, as shown in Figure 11.

The strong backs are provided at the corners of the house and at each wall pier, as shown in Fig. 16. The corner strong backs help to inter-connect the orthogonal walls to prevent corner separation. The type design provides the option to construct the strong backs constructed out of either reinforced concrete or good quality timber.

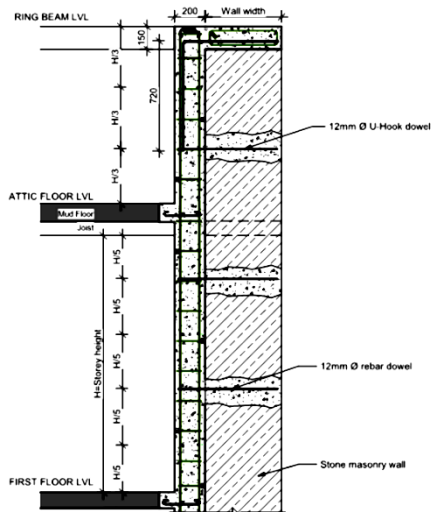

Figure 11: Detail of strong back installation

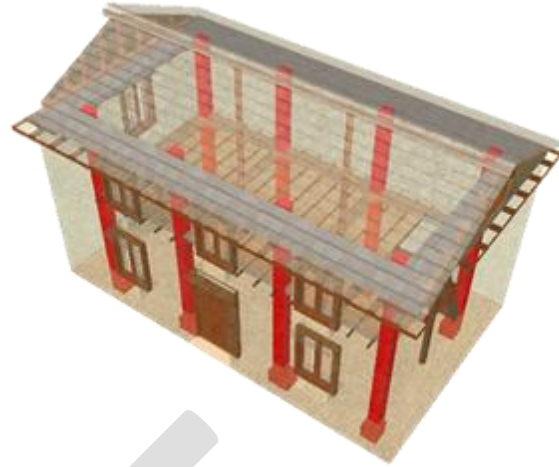

Figure 12: Position of strong backs (indicated in red) in a house

Slab strip for diaphragm strengthening - The function of the slab strip is to improve connectivity of all walls to the diaphragms and to each other, creating a box effect. Also, it is connected to the joists and functions as a chord element at the edge of the diaphragm increasing the diaphragm stiffness and strength. In order to strengthen the floor diaphragm and provide chord and cross-tie elements, as well as strengthen the connection of the walls to diaphragm, reinforced concrete slab strips are installed along the inner perimeter of the walls and cross connecting intermediate strong backs. The slab strips aid in distributing the out-of-plane loads to the perpendicular walls.

The slab strips are connected to the existing joists through rebar dowels. Dowels are also placed along the perimeter strips at a spacing of 600mm center to center and embedded with grout in the adjacent wall as shown in Figure 13 and Figure 14.

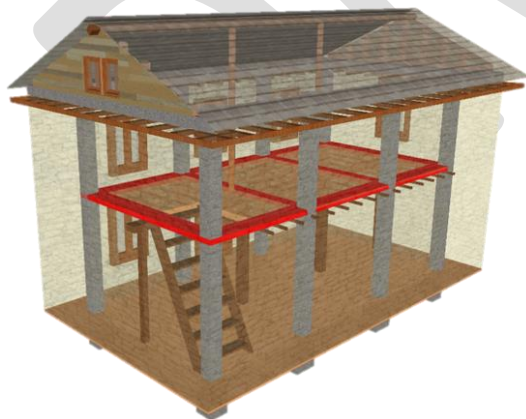
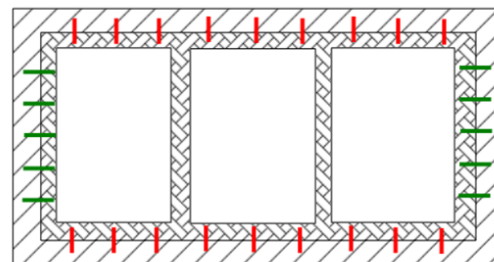

Figure 13: Slab strip (indicated in red) connects the diaphragm to the walls as well as interconnects the strong backs







-  SMM wall
-  RC slab strips
-  Through Dowels to transfer the out-of-plane forces from the slab strips to the in-plane walls parallel to the X-direction
-  Through Dowels to transfer the out-of-plane forces from the slab strips to the in-plane walls parallel to the Y-direction

Figure 14: The red and green lines indicate dowels spaced at 600mm that connects the slab strip to the walls

Plastering of walls - The SMM walls are plastered at the exterior and interior face. The plaster together with the through concrete, contributes to increase the capacity of the wall in the in-plane direction. In cases where the wall pier is slender and/or the quality of masonry work is very bad, the wall piers are jacketed with welded wire mesh on both sides.

Improving existing timber connections - The existing timber connections are generally acceptable for gravity loads but not for wind and lateral loads. So, simple improvements in connections using galvanized iron wires and/or corrugated galvanized iron straps are provided to the roof, as shown in the photo in Figure 15.



Figure 15: Improvement of existing timber connection

Cost of Strong back

The cost of retrofitting a house using strong back technology is given in the table below. The per unit area cost would vary based on how big the building is and the number of stories.

Retrofitting approach	Number of storeys	Cost of retrofit NPR/m ²	Mean liveable floor area (m ²)	Total Field Cost (NPR)
Strongback	1.5	7,000	50	350,000
	2	7,500	50	375,000
	2.5	5,000	110	550,000

Retrofitting Methodology	No of houses	Average Area (m ²)	Average Cost (per m ²)
Strong back	225	74.91	6012

GI Welded Wire Mesh Splint and Bandage (with Local Failure Jacketing) Approach:

The splint and bandage technique for retrofitting has been in common use in Nepal since the late 1990s. Several hundred schools, private and public buildings had been retrofitted using this approach prior to the 2015 Gorkha earthquake. However, most of these buildings were cement based masonry in urban areas, and primarily used reinforced concrete. Other materials such as Welded GI Wire Mesh and Polypropylene Bands were also used in retrofitting, although few in numbers. The method is also based on the designs prescribed in the Repair and Retrofit Manual for Masonry Buildings published by the National Reconstruction Authority in June 2017.

The splint and bandage design consists of vertical splints, at building corners, wall intersections and on either sides of the openings, and horizontal bandages, at sill, lintel and floor levels. The wall area not covered by the splint and bandages are covered by wire mesh that confines the walls. Galvanized

iron wire mesh was used for the splints and bandages. Although there are other options for splint and bandage also mentioned in the Repair and Retrofit Manual such as reinforced concrete, timber, etc., this document will consider the use of the galvanized iron wire mesh as it was found to be more cost effective, applicable and acceptable at the community level, especially in stone in mud masonry buildings.

The function of the splints is to add in-plane capacity and stiffness to the walls. The splints at the edge of the piers, provides tension capacity to the walls. The splint comprises galvanized iron wire mesh installed on either side of the wall. The wire mesh installed on the inside and outside is connected by rebar anchors at regular intervals. The wire mesh thus installed is fixed at the bottom by a plinth beam. The function of the bandage is to tie the walls together to provide box action. The bandages are similar to splints in terms of materials used and details but are horizontal instead of vertical bands.

The function of the plinth beam is to anchor the rebar in the splints and confining reinforcement and connect it back to the wall foundation. The confining reinforcement consists of a galvanized wire mesh that helps to contain the masonry wall in case of shaking during earthquakes, preventing disintegration. The inside and outside confining reinforcement is connected to each other with the help of wire anchors.

Cement sand plaster is applied on the outside and inside of the walls to cover all the reinforcement. The cement sand ratio used in splint and bandage design is richer in cement compared to strong back approach. Other works such as replacing heavy gables with light, well connected ones and overall improvement in connection of existing timber members were done similar to strong back approach.

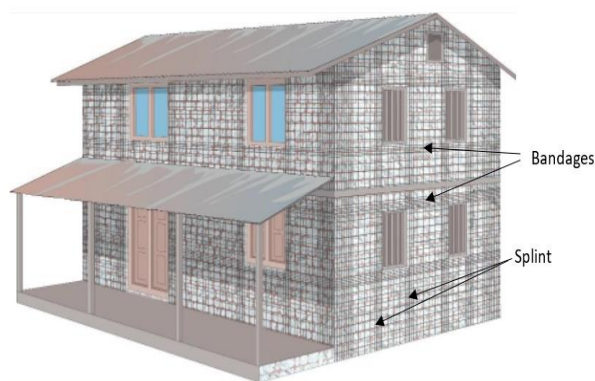

Figure 16: Schematic of splint and bandage approach (Repair and retrofit manual)



Figure 17: Retrofit of a house in splint and bandage approach

Research and Development

While Splint and Bandage technique had long been in use in Nepal, its research and applicability was limited for rural masonry buildings, especially stone in mud mortar. The huge demand for retrofitting as a result of damages in rural buildings during the 2015 Gorkha earthquake required extensive study on the material and techniques for retrofitting at a feasible cost.

Figure 18 below shows the ultimate load and ultimate lateral displacement obtained from push over tests conducted in stone masonry walls with various strengthening options.

The P-D curve shows that the Unreinforced Stone Masonry (S1:NR) has a ultimate lateral displacement of 38mm. Similarly, stone masonry wall reinforced with built in wooden bands and posts (S2:WB) had an ultimate lateral displacement of 57mm. Consecutively, addition of gabion wire meshing to the

wooden bands and posts (S3:WB+GWJ) increased the lateral displacement capacity to 134mm, a 252% increase in displacement with respect to unreinforced masonry. However, since addition of built in wooden bands and posts is not feasible in retrofitting, all reinforcements must be added on the surface of the wall. As such, a feasible technique is the use of gabion wire meshes as splints, bandages and jacketing (S6: GWJ+GWB) which increases the ultimate lateral displacement by 389% to 185mm.

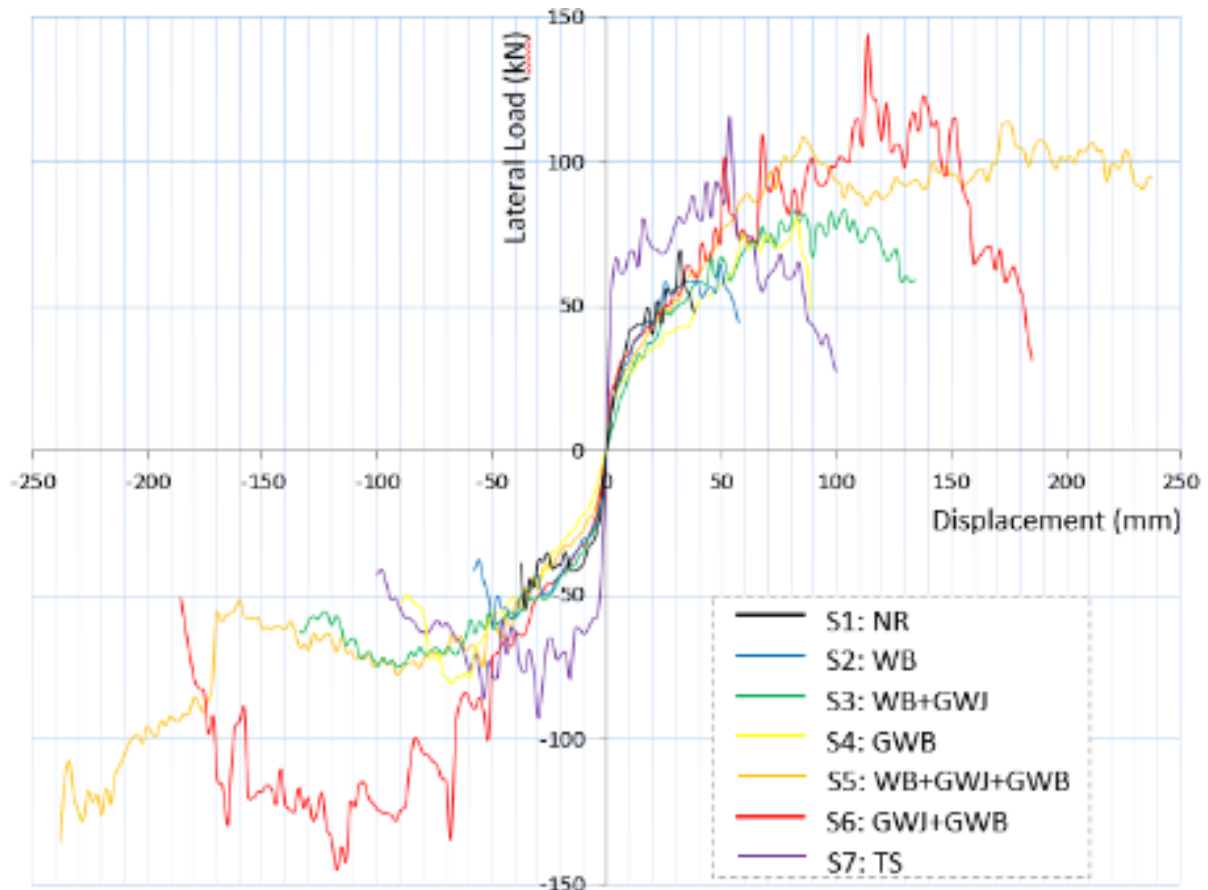

Figure 18: Ultimate load and ultimate lateral displacement obtained from push over tests conducted in stone masonry walls with various strengthening options

Further, shaking table tests were conducted for better understanding the level of safety that can be achieved from this type of the retrofitting techniques. The left building (look at the picture) shows it was damaged by 0.3g El Centro earthquake and the right picture shows the same building built with simple GI wire mesh jacketing survived up to 1g. It was one of the most reliable shaking table tests which most of the professionals globally rely on in terms of implementing new technology for earthquake safety. Those results gave a lot of confidence especially on reliability of seismic retrofitting of rural housing. The test was conducted jointly by Beijing Normal University and NSET in China in 2017.

Construction Procedure



Scaffolding and Shoring: To stabilize the damaged structure and provide access to various parts of the building during the retrofitting construction process, adequate shoring and scaffolding of the building is done.



Stripping of Plaster: To provide clean, dry and uniform surface for placement of wire mesh splint, bandages and plaster, the existing plaster of the building is stripped using tools such as wire brush, chisel, hammer etc. The surface is then cleaned to remove all loose materials, either by air pump or water.



Architectural Modifications: Where necessary, architectural modifications are done. These primarily consist of constructing partition or buttress walls to increase wall strength, removal or addition of openings, removal of heavy gable walls, strengthening or replacement of existing damaged timber structure, replacement of roof covering etc.



Placement of Foundation Tie Beam: A foundation tie beam is placed at prescribed location alongside all the walls of the building. For this, a trench is dug out alongside the walls and rebars with adequate lateral ties are placed. The role of the beam is to tie all vertical reinforcements and support transfer of load to the foundation.



Placement of Splints and Bandages: The vertical splints and horizontal bandages are then placed in respective locations on both sides of the walls. Bandages are tied to the splints while splints are tied at the foundation beam.



Placement of Anchorage: To tie the wire mesh used in splints, bandages and local failure jacketing on both sides of the walls, anchorages are placed at regular locations. These anchorages can be half (using 4.75mm rebar) or full (using GI wire) to adequately tie the reinforcements to the walls. Holes are drilled at specific locations, either before or after splints and bandages placement.



Providing GI wire jacketing for local failure control: After placement of Splints and Bandages, GI wire mesh is prepared on-site to control local failure. Such a mesh is provided on all remaining parts of the walls where splints and bandages were not placed. Anchorages are provided in these meshes as well to connect the inner and outer layers.



Concreting Foundation Beam: After completion of placement of all splints and bandages, concrete is placed in the foundation tie beam.



Plaster and Curing: The whole surface of the wall is then plastered using Cement Sand Mortar to ensure adequate coverage of the GI wires and meshes. The plaster ensures the longevity of the construction materials used.

Prior to plaster, walls are cleaned properly using brushes and sprayed with cement slurry to provide better bond.

Plastered surface is cured with ample water for upto 14 days.

Cost of splint and bandage retrofitting

Retrofitting Methodology	Organization	No of houses	Average Built Up Area (m2)	Average Cost per Built Up Area (per m2)
Splint and Bandage	UNOPS	27	89.56	7700
Welded GI Wire Mesh Splint and Bandage with Local Failure GI Wire Jacketing	NSET	60	88.07	5562

Containment Reinforcement integrated Splint and Bandage technology

Principles of seismic retrofitting

While developing CR integrated Splint and Bandage technology for retrofitting, the following elements were critically evaluated for technical and economic feasibility of retrofitting of the unreinforced masonry buildings in mud or without mortar:

- Minimum cost of the intervention
- Minimum downtime
- Minimum intervention
- Minimum discomfort to the building occupants.

General approach for seismic retrofitting

The focus of the seismic retrofitting was the following:

- Improving the building integrity:** Stone and brick masonry buildings typically suffer from a lack of integrity. Hence, it is very important to improve the integrity of these buildings to achieve “box effect”. Box effect can be achieved, by providing positive connections between the lateral load resisting elements so the seismic forces can be transmitted to the members that can resist them.
- Avoid brittle and sudden failure modes.** The retrofit should eliminate possibility of failure of connections or toppling of walls which are undesirable modes of failure.
- Increase lateral strength.** Improve the lateral strength of building components such as out-of-plane stability of walls and in-plane shear and bending strength of walls.
- Eliminate sources of weaknesses.** Eliminating features that are sources of weakness such as a lack of through-stones in walls leads to delamination or connection between cross walls.
- Improve uniformity.** Asymmetrical plan of masonry buildings and large openings in the walls are a source of stress concentration in certain elements that could lead to premature failure.
- Reduce building weight.** Lighter buildings generally suffer less damage than the heavier ones even though both may have been constructed using similar building materials and techniques.

Technical approach

To meet the general principles of seismic retrofitting following the above discussed approach, the following was recommended for retrofitting of these buildings:

- **Splint and bandages:** The splint and bandage system can be considered as an economic version of shotcrete jacketing where reinforcing bars are provided at most critical locations, i.e., wherever tensile stress can develop. The bandages are thin horizontal reinforced concrete elements. These were provided on both surfaces of walls at sill, lintel, floor and eaves levels. Plinth bands were provided only on the outer face of the building were required. In addition to providing out of plane stability of masonry walls, the bandages will also enhance shear capacity of masonry walls. Splints are thin vertical reinforced concrete elements provided along the wall junction. In addition, openings were also surrounded by splints and bandages to prevent initiation of cracks from their corners. These were provided in the external face only. The goal was to supplement tensile strength in the vertical direction. Furthermore, the splints would also prevent the masonry being dislodged due to cracking. It is expected that the piers might suffer diagonal cracks, but these cracks will be restrained from widening by vertical steel provided in the splits at the ends of the piers.
- **Containment mesh:** To basket and thereby prevent disintegration of the stone masonry walls, 3mm diameter galvanized steel wires were provided in both horizontal and vertical direction on both surfaces of the walls, which were tied together by cross links (cross ties) passing through the walls. These crosslinks also mitigate delamination of stone masonry walls.
- **Tying member together:** Elements of floor/ roof such as floor beams and joists, roof beam and rafters were tied together to improve integrity and floor/ roof structure. The floor joists and

roof rafters and beams were also tied with the walls. Posts supporting floor and roof were tied to the floor/ roof.

- Floor and roof bracing: Floor and roof bracings made of multiple strands of wires were provided to both floor and roof structure to improve their in-plane stiffness. The ends of the bracing were tied to walls.
- Gable walls: Gable walls were either deconstructed and replaced by timber structure clad with timber planks or CGI sheets or new gable band was provided and then the wall was secured to the roof structure

CR integrated Splint and Bandage technology based on IS: 13935 (particularly for Splint and Bandage) and its enhancement through its integration with the Containment Reinforcement technology developed based on experimental method that has been approved by the Government of Nepal (Volume II Catalogue: Alternative Technology). This retrofitting technology enhances the seismic performance of the building by using containment reinforcement with splint and bandage, thus increasing its integrity, uniformity, and strength of a building to resist seismic forces.



Below table has been directly referenced from the scientific paper enlisted in the annex and it presents photographs of actual implementation of retrofitting of stone masonry buildings.



Stage 1: Securing the “Bandages” horizontally on walls

Horizontal bandages are secured on the walls of each floor on both faces of the wall, one pair below the floor level and other pair on the mid height level of the wall dividing the height approximately into two parts. The bandages use GI weld wire meshes (WWM) which are secured with the masonry walls with one shear connector at each wall junction, cross-links which are placed at 600 mm away from each other horizontally in a staggered manner within the width of the WWM at a distance of 2 feet from each other. The cross-links connect the pair of WWMs on inside and outside faces of the walls together. Additional nails (with washers), which are inserted into the stone masonry at a distance of 1 feet over the WWM. GI WWM - 2mm \varnothing GI wires welded with each other in a square (approximately 1" X 1") grid

Shear connector - 8 mm \varnothing L shaped re bar secured with the help of cement concrete in the stone masonry

Cross-links - Two, 2mm \varnothing GI wires twisted with each other and projecting out of the wall on both faces of the wall



Stage 2: Securing “Splints” vertically at critical junctions of the walls

Vertical splints are secured on all critical junctions of the walls and on the mid-span of long walls starting from 450mm below plinth level upto the top of the wall at roof level, shear connectors are placed vertically beforehand (1 \emptyset mm GI binding wires are used at least at two locations on the shear connectors). The weld wire mesh (WWM) end projects out 150 mm at the bottom of the splint and 10 mm \emptyset steel bar cage is put over it, 6 mm \emptyset U hook hammered into the masonry joints to hold down reinforcement, form work is then installed and M20 concrete is poured with proper compaction. At the opening jambs, splints are secured with additional reinforcement on both faces of the wall if the opening size is beyond 3' \times 3'.

Stage 3: Containment Reinforcement wires (vertical & horizontal) put in place

The remaining walls are protected with vertical and horizontal 4 mm \emptyset GI wires in a square grid with a distance of 16" between each other. The tying of the cross-links, which are already placed on the walls, over each vertical GI CR wire starts with the bottom most cross-link which is 3" above the floor level and proceeds to the top over all the horizontal bandages already fixed at different levels. Vertical GI CR wires coming from the bottom on both faces of the wall meet at the top of the wall and are crossed over each other, and secured with the help of nails on horizontal wooden element or are extended until the top most cross-link and tied with the same after crossing over the wall. The 4 mm \emptyset GI CR wires are placed on horizontal alignments and run through both faces of the walls. The wire are secured with the help of cross-links.



Stage 4: Ensuring flexible diaphragms at floor and roof level and ensuring connections between wall structure and roof structure

In-plane diagonal tie in X configuration made of 2-2mm are put in place at the floor under structure and roof understructure. It is ensured while installing bracing under roof with tie ends connected to roof timber and the bracing ends connect rafters and purlins. It is also ensured that rafters and purlins (nearest to the top most bandage) are connected with the wall system by 2-2mm GI wires at multiple locations. The installation of the retrofitting system is thus completed and is ready for plaster.

Though the retrofitting work was completed in a week, the elements (bandage, splint, vertical and horizontal wires) were installed in stages, which can be implemented in an incremental approach, spread across a period of time, upon availability of funds. These buildings could be further strengthened, if desired, by applying ferro cement plaster to the wall surfaces

Cost of CR integrated Splint and Bandage retrofits

Retrofitting Methodology	No of houses	Average Area (m2)	Average Cost (per m2)
CR integrated Splint and Bandage	30	80	NPR 3640

Retrofitting of timber houses:

The retrofitting approach taken is to comply with the requirements of Light timber and steel structures manual published by the Government of Nepal. This consists of designing a timber bracing scheme including the lateral bracing capacity of masonry walls as well in case of timber frame with masonry wall. In addition, the existing timber connections of the roof, the timber system and between two floors are improved. The stability of the masonry wall is also ensured to prevent failure due to overturning.

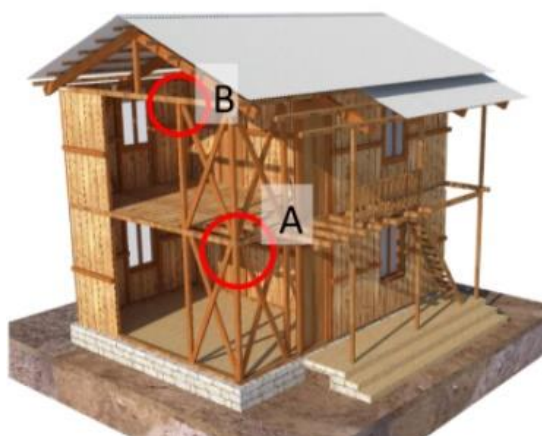

Figure 19: Schematic of timber house retrofit approach

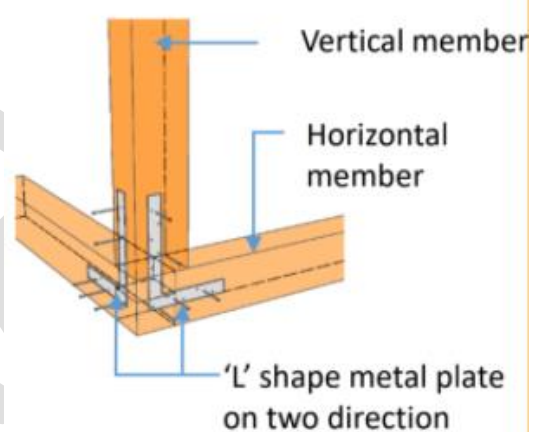

Figure 20: Detail at A; Connection at corners

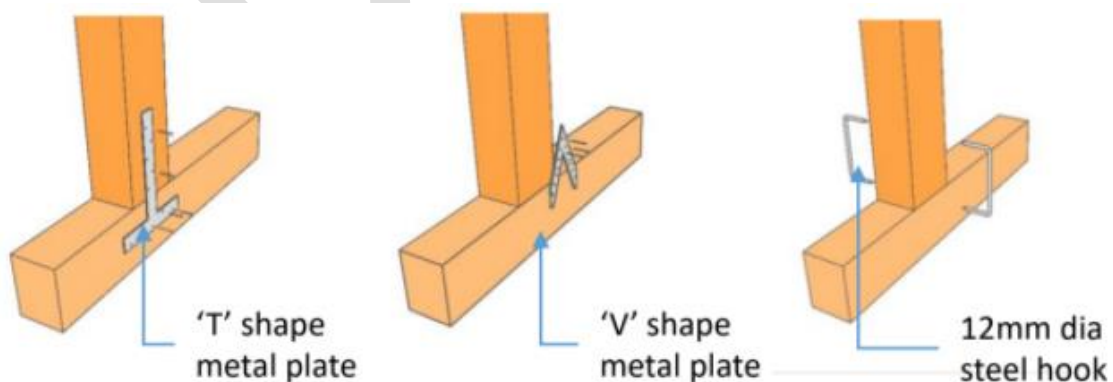

Figure 21: Detail at B; Horizontal and vertical connections at intermediate locations

Cost of timber retrofitting

Retrofitting Methodology	No of houses	Average Area (m2)	Average Cost (per m2)
Timber	30	59.02	4110
Timber with Masonry Ground floor	10	54.5	4523

Design guidelines and technical manuals

DUDBC has published various guidelines and manuals to support the retrofitting process. The manuals range from ones that support engineers for designing retrofits to guidelines that offer quick solutions that even an engineer new to retrofitting can use to offer retrofitting advice and solutions to homeowners post-earthquake. Some of these guidelines are mentioned in brief below:

Seismic Retrofitting Guidelines of Buildings in Nepal

There are significant number of non-engineered and semi-engineered buildings in Nepal which were built before the code was implemented that are vulnerable to earthquakes and need to be strengthened for withstanding future earthquakes. This vulnerability was exposed in urban and rural areas during the earthquake when a large number of these type of houses were damaged. This document was endorsed by the Government of Nepal in 2016 to provide guidance for engineers to design retrofits. The document consists of three parts covering three major typologies of buildings common to Nepal which are:

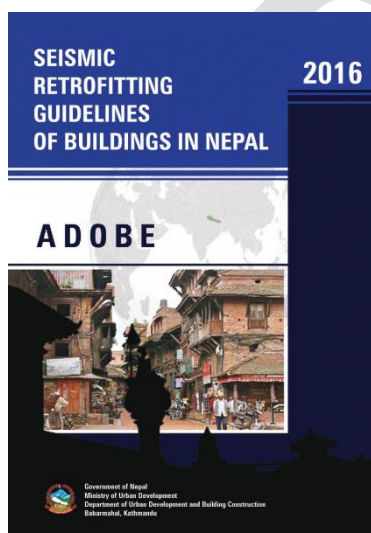

Figure 22: Seismic retrofitting guidelines of buildings in Nepal - Adobe

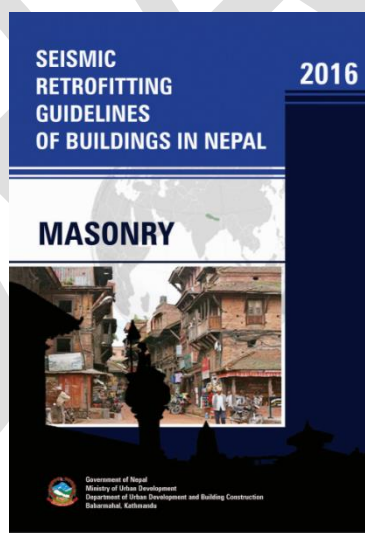

Figure 23: Seismic retrofitting guidelines of buildings in Nepal - Masonry

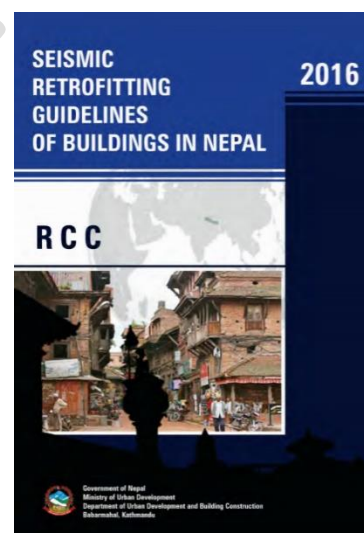

Figure 24: Seismic retrofitting guidelines of buildings in Nepal - RCC

The purpose of this document is to act as a guiding document for design professionals with the purpose of providing analysis and design methodology for use in the seismic evaluation and retrofitting of the existing buildings in Nepal.

Repair and Retrofit Manual for Masonry Structures

This manual was published by the NRA to support the minimum interventions works required to carry out the retrofitting works on the houses categorized as damage grade 2 and damage grade 3 under the GoN reconstruction programme. This manual will support the engineers to provide advice and guidance to homeowners for implementation of repair and retrofitting strategies. The document also covers policies for distribution of tranches within minimum technical intervention options. The manual can be used for residential houses of a specific size only. This guideline recommends four approaches for retrofitting:

RC splint-bandage and GI wires in remaining part

Welded GI wire mesh Splint-bandage and GI wire jacketing

Welded GI wire mesh Splint-bandage and PP band jacketing

Wooden splint-bandage and GI wires jacketing

Repair and Retrofit manual for RCC structures

This manual was developed and published by NRA to aid the Government engineers to evaluate retrofit works and to support them to give necessary advice to the homeowners regarding retrofitting of Reinforced Cement Concrete (RCC) framed structures. Retrofit approaches such as reinforced concrete jacketing methods, use of carbon fiber reinforced plastic jacketing, etc. are mentioned in the manual. As RCC structures are expected to be engineered and are relatively complex than the masonry structures, use of this document has been limited, while the manual has been referenced by the engineers as the resource material.

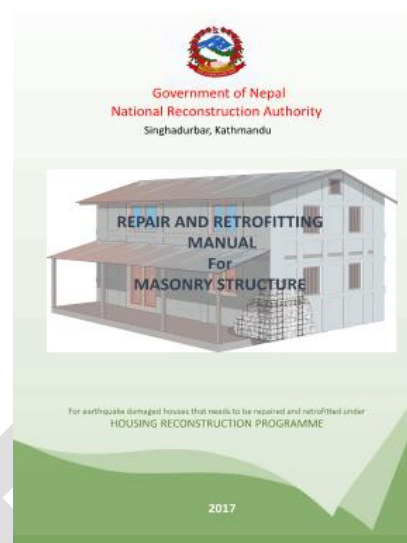

Figure 25: Repair and retrofit manual for masonry structures



Figure 26: Repair and retrofit manual for RCC structure

Engineering manual: Standard Type Design Retrofits of Stone Masonry with Mud Mortar (SMM)

This manual provides the engineering basis, limitations and design of the approved retrofit type design for SMM builds using the strong back approach. The manual clearly communicates the applicability and restrictions of the type design and provides guidance to engineers on how to use and how not to use the type design ready-to-use details.

This manual can be used by relatively young engineers to provide solutions to a wide range of SMM houses that complies to the prescribed applicability criteria.

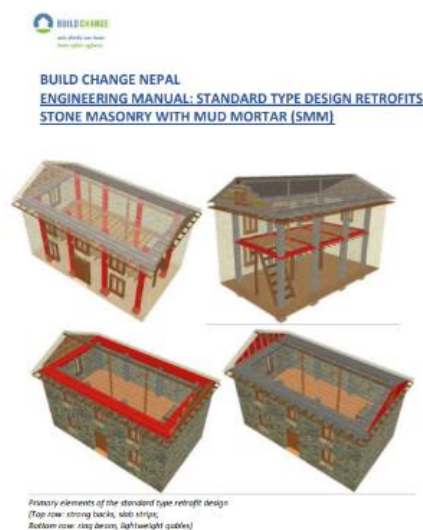

Figure 27: Engineering Manual: Standard type design of SMM buildings (strong back approach)

Draft Norms for Rate Analysis of Retrofitting Masonry Building

A retrofit technical working group was formed on 20th December 2019 to support the

NRA, CLPIU Building to speed up retrofitting of buildings in earthquake affected areas through standardization of technical documents, solutions and approaches related to retrofitting. This group consist of partner organizations, namely, NSET, Build Change, UNDP and HRRP who are actively working in retrofitting in the earthquake affected districts of Nepal. Retrofitting Norms for Rate Analysis is one of the main documents prepared by the retrofitting technical working group. This document provides basic guidelines of norms for load-bearing masonry structures.

This document contains vital information to estimate the bill of quantities of various civil construction works that are unique to retrofitting.

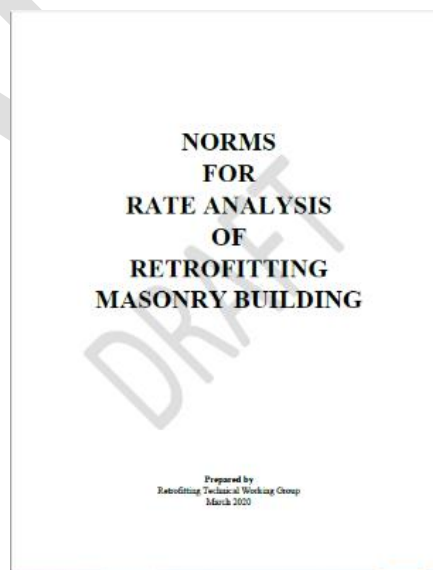

Figure 28: Norms for rate analysis of retrofitting of masonry buildings

Public outreach, information and awareness

As retrofitting is a new concept that has not yet penetrated within the mindset of the house owners and the decision makers, it takes a multi-prong approach to develop common understanding on the need, benefits and the ways to retrofit the houses. Public outreach through Information, Education and Communication (IEC) is key to raise awareness on the concepts of retrofitting and thus capacitating the house owners, masons and engineers to take informed decisions and information is key to empowerment. As the process involves various stakeholders such as homeowners, masons, rural municipalities and urban municipalities, engineers, policy makers and other officials, who have different roles and responsibilities and have different abilities and capacities to promote retrofitting, their sensitization on retrofitting becomes essential. Hence, IEC approach needs to consider diversity in terms of end users to produce tailored materials targeted at them. Various IEC materials in the form of videos, flyers, posters and booklets have been produced by different partners focusing on various aspects of retrofitting to support post 2015 earthquake recovery. Various mediums and methods have been chosen to expand the outreach, making the information sharing less technocratic and more inclusive. These IEC materials have been compiled and uploaded in the drive that can be accessed through the [Index](#).

Methods and Mediums used:

Videos – Various partners have produced videos capturing multiple aspects of retrofitting. There are fourteen videos prepared to provide conceptual clarity on retrofitting targeting general public, technicians and the policy makers. These videos mainly focus on what retrofitting is and the need to retrofit, what are the benefits of retrofitting, testimonials of the house owners who retrofitted their houses, and how to initiate the retrofitting once to plan to retrofit your house. There are also videos focused on building confidence of the stakeholders and house owners on retrofitting, through demonstration of shock and shake table tests of retrofitted houses, along with experts providing their guidance and explanations on the benefits of retrofitting.



Figure 29: Spreading information of retrofitting through video messaging

Public service announcements – Short informational videos to give basic information on retrofitting including explaining what retrofitting is and how it can be done, explaining technical information regarding retrofitting in non-technical and simple ways.

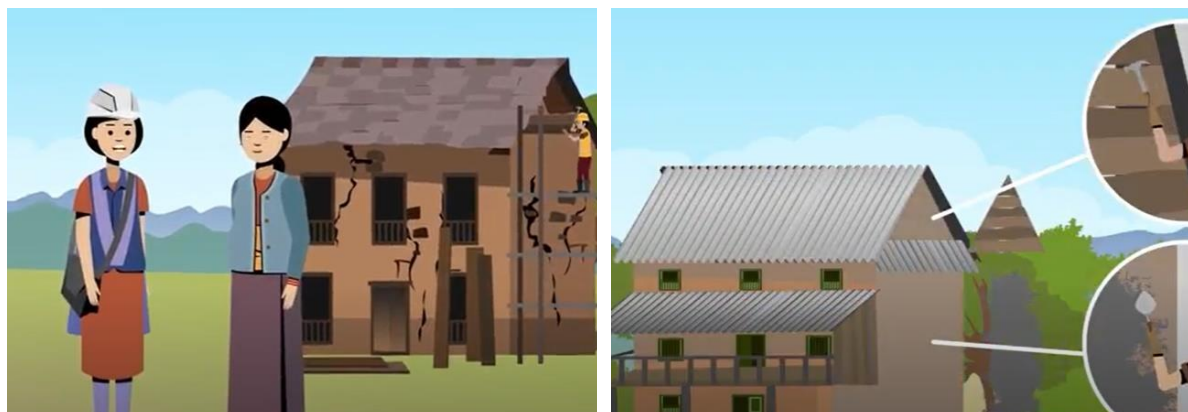

Figure 30: PSAs on retrofitting

Booklets – Two different booklets have been produced, that is handy for both house owners and technicians. These handbooks are in Nepali language and are focused on ten key points to remember while undertaking retrofitting and a visual guideline to provide technical details and conceptual clarity on repair, restoration and retrofitting approaches. These booklets use visuals to help the people better understand the technical details.

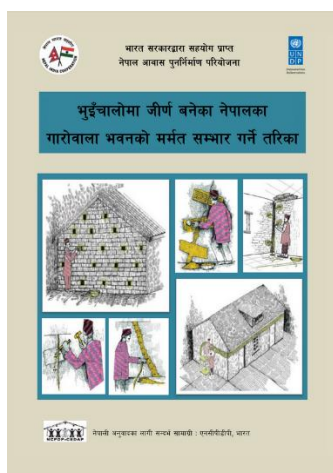

Figure 31: Booklets on repair and restoration



Figure 32: Booklet on 10 points to remember in retrofitting

Posters – Three different types of posters have been produced for various target groups, raising mass awareness on both technical and financial aspects of retrofitting. The posters targeting house owners are focused on cost comparison between retrofitted and newly constructed house and Ten key points to remember while planning to undertake retrofitting. Likewise, a set of 6 posters have been produced for masons and engineers to provide step-by-step guidance on undertaking containment reinforcement integrated splint and bandage technology.

Innovations

Acknowledging that the retrofitting is a new concept and making the people understand it requires a multi-prong approach, various audio-visual and print means have been used to increase outreach and insure inclusivity in the approaches. Various radio programs and jingles have also been prepared for mass awareness and broadcasted through local radio stations in the earthquake affected districts.

As the people in the villages are more comfortable to the visual mediums than the write-ups, priority has been given to prepare videos that is more interesting, understandable and even sharable using various social media. Likewise, the print materials have also focused on illustrating using visuals.

Videos have been developed to introduce innovations in terms of technologies developed for retrofitting as well as seismic assessment using artificial intelligence, that provide ideas on possibilities in strengthening the buildings to mitigate pre-existing vulnerabilities.

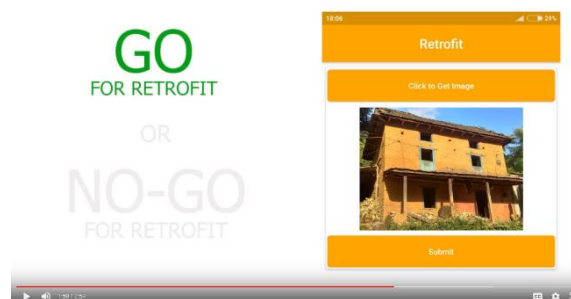

Figure 36: Using Artificial Intelligence to aid retrofitting process

Capacity building

Different partner organizations developed different training resources for retrofitting based on approach and requirements. Some of the major trainings that were given to engineers and builders are described in brief in this section:

Builder trainings – 50-day OJT for strong back approach

A CTEVT approved On the Job builder trainers manual and a picture guide for strong back retrofitting was developed and approved by CTEVT. A detail competencies list required to retrofit a house was also produced. Based on these competencies, an OJT schedule was developed. Engineers and builder trainers delivered training on site for the builders during the construction of model houses. The training included:

- Safety and site management
- Basic construction tasks
- Shoring and scaffolding
- Repair works
- Installation of ring beam, strong backs, timber member splicing, slab strips, through concrete, gable wall
- Connection improvements at the roof, porch and balconies
- Plaster and wall finish



Builder trainings – 5-day OJT for CR integrated splint and bandage approach

Training curriculum for OJT on CR integrated splint and bandage has been developed for training of the local masons on retrofitting. It is a 4-day training package, with both theoretical and practical sessions, providing opportunity to work on-site on the house covering major elements and aspects of retrofitting. The training is planned and rolled based on the step-by-step manual developed to execute the retrofitting on a house and it is as follows:

- First day the masons are provided orientation on repair and retrofitting with over view of the training process. It is followed by practical sessions on dismantling or repairing assessment and mark-ups for placement of splint, bandage and cross links leading to placement of belts and shear anchors
- Second day is mostly practical and focused on placement of splint at corners and openings
- Third day's theoretical session is focused on retrofitting of roof and flooring elements. Practical sessions are focused on splints at corners and openings, vertical wires, in-plane diagonal wires for floors
- Fourth day is mostly practical session focused on placement of vertical and horizontal wires, in-plane diagonal wires for securing roofs and roofing elements. Further observations, identified issues, planning next steps are discussed.

Upon completion of the 4-day training, as formally agreed with the house owners prior to the training, the same masons are continued for next 4 to 5 days to complete the retrofitting of the house, where the house owner bears the cost of masons and materials. During this whole process, the technical team of the project provides hand-holding support to the masons to complete retrofitting, helping them to apply their acquired knowledge and skills. Thus, though the training package from the project is only for 4 days, the masons are further engaged until completion of retrofitting of the house, which provides them opportunity to understand all elements of retrofitting in a house and develop skills to address any issues. 4-day masons training is followed by 1-day refresher training to boost confidence of the masons and address any issues they have faced while working in the field, further honing their skills.

Builders training – 25 days OJT for splint and bandage approach

This training program intended to enhance the capacities of existing skilled masons to help in the retrofitting of partially damaged houses in post-quake reconstruction campaign. Additionally, as part of the training program, a partially damaged house is retrofitted by the trainee masons and is then utilized for local awareness and capacity building site as a demonstration model. Thus, the training serves two purposes, capacity building as well as demonstration.

The training is based on a 25 Day curriculum developed following the standards of other on-the-job training curricula developed by CTEVT and endorsed by the NRA.

The major objectives of the retrofit training are as follows:

- To enhance the capacity of skilled masons working in the field of housing construction to undertake the retrofitting of partially damaged stone and brick masonry buildings.
- To repair and retrofit partially damaged houses at local level as demonstration models to aware local people on technology and feasibility of retrofitting using locally available human resource and materials.
- To enhance understanding of local communities and stakeholders in increasing the seismic capacity of existing damaged and undamaged building, thus driving towards disaster resilient communities.

Engineers training – competency-based OJT for strong back approach and splint and bandage approach

A list of key construction stages were developed for strong back approach and splint and bandage approach. The engineers were required to visit any retrofitted house to learn each of the key construction stages. A certificate was provided to the Engineer once the engineer completed each of the key construction stages and a competency test was carried out to determine the knowledge gain.

Engineers trainings – 4-day OJT for CR integrated splint and bandage approach

Training curriculum for OJT on CR integrated splint and bandage has been developed for training of the engineers. It is a 4-day training package, with both theoretical and practical sessions, providing opportunity to work on-site on the house covering major elements and aspects of retrofitting. The training is guided by a step-by-step field manual prepared specifically for the engineers, which is focused on fundamentals of retrofitting and field level implementation. The trainings also included qualitative seismic assessment of existing buildings, identification of deficiencies, intervention strategies, quality control, adjustments in retrofitting elements, etc.

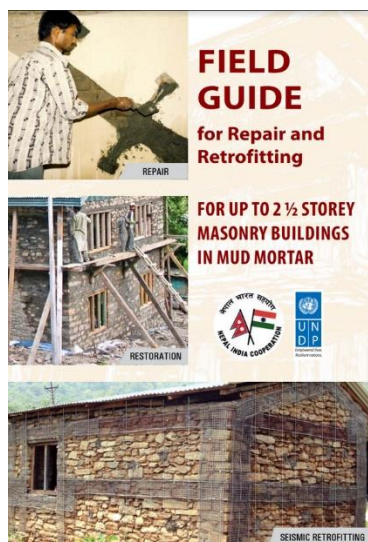

Figure 37: Step-by-step field manual for engineers retrofitting using CR integrated Splint and Bandage technology (SMM)

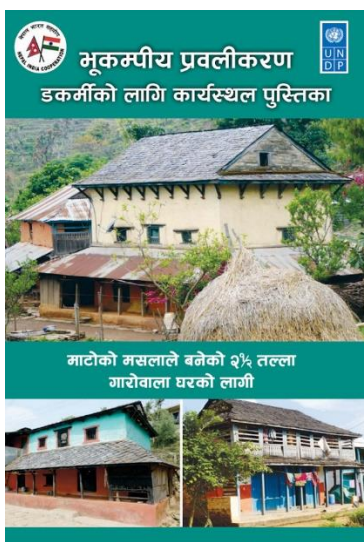

Figure 38: Step-by-step field manual for masons retrofitting using CR integrated Splint and Bandage technology (SMM)

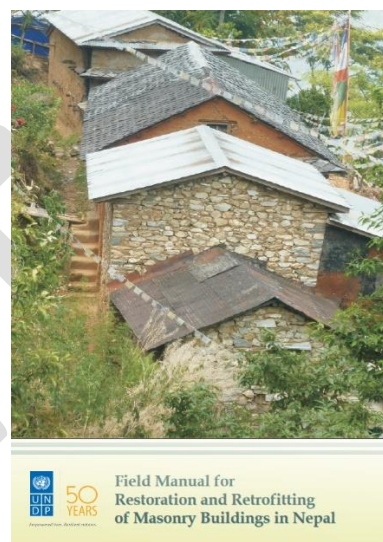

Figure 39: Field manual for retrofitting of masonry buildings (following GON approved retrofitting guideline)

Engineer trainings – 4-day classroom training including site visits

A curriculum and the training materials targeted to train the field engineers working on retrofitting was developed. The training was conducted over 4 days and NRA engineers from 32 Districts attended the training. Local district “Hubs” were created so that trainees from nearby districts could be grouped together for efficiency, timely delivery and ease of mobilization.



The training covered the following:

- NRA Grant Distribution Process, the formalities and legalities of it;
- NRA's Repair and Retrofitting Manual;
- DUDBC's Retrofitting Guidelines;
- Case studies based on the approved designs
- The innovative tools used in Reconstruction.
- Strong back and splint and bandage approaches in retrofitting
- Practical training on strong back and splint and bandage technology

The training was based on the approved curriculum from the CLPIU (Building). In addition to the field visits and group discussions, in class lectures were held with Audio-Visual materials and PowerPoint slides.

During the training, as necessary, field visits were conducted to demonstrate the techniques learnt in the classroom as well to give the participants an opportunity to put into practice the techniques learnt. The demonstration included the retrofitting techniques from NRA's Repair and Retrofitting Manual and CLPIU approved Strong Back Design.

A pre-test and posttest evaluation of the participants were conducted to test the knowledge of the participants after the training.

Engineers and Sub engineers Training – 4-day on Inspection Training for Retrofitting

The training was conducted for engineers and sub engineers deployed in the earthquake affected areas through the National Reconstruction Authority. As these engineers were responsible for the supervision and inspection of retrofitting for quality control as well as grant disbursement, the training focused on theoretical aspects of retrofitting as well as practical aspects, including quality control measures and supervision approaches. Additionally, the participants were also oriented on the inspection criteria and forms developed by the NRA with field visit to a retrofit site to demonstrate on field applications of the inspection forms.



Engineers Training – 5-day on Masonry Retrofit Design Training

The training was targeted to engineers and designers with advanced knowledge on engineering and seismic design. The main objective of this training program was to enhance the participant's know-how on earthquake impact on masonry building structures, understand seismic performance of masonry buildings and be able to perform the structural analysis and retrofit design of load bearing masonry buildings using the Splint and Bandage technique. The course was conducted over five days covering the basics for seismic analysis and design of masonry buildings to impart the knowledge/concept on the performance of masonry buildings in earthquake load.

The mode of the training was in power point presentations, practical exercises by trainees, group presentation by the participants, discussions and experience sharing. After completion of the training the participants should be able to understand the concept of analysis and retrofit design of masonry buildings.

Stock taking

Socio-technical facilitation: Post 2015 earthquake, handful of partners have been working on retrofitting, providing socio-technical facilitation with door-to-door and tailored support through the mobile technical teams, intensive and comprehensive outreach means using various IEC materials, capacity building of the local government, NRA engineers and particularly local masons through on-the-job training to construct demonstration buildings for extensive sensitization to infiltrate the understanding and need of retrofitting.

Retrofitted houses: The partners have supported in retrofitting of 387 houses spread across 21 earthquake affected districts. Of which, concentration of these houses are higher in Sindhuli, Dhading, Gorkha and Kavre. Likewise, Government of Nepal has also supported in retrofitting of additional 333 houses.

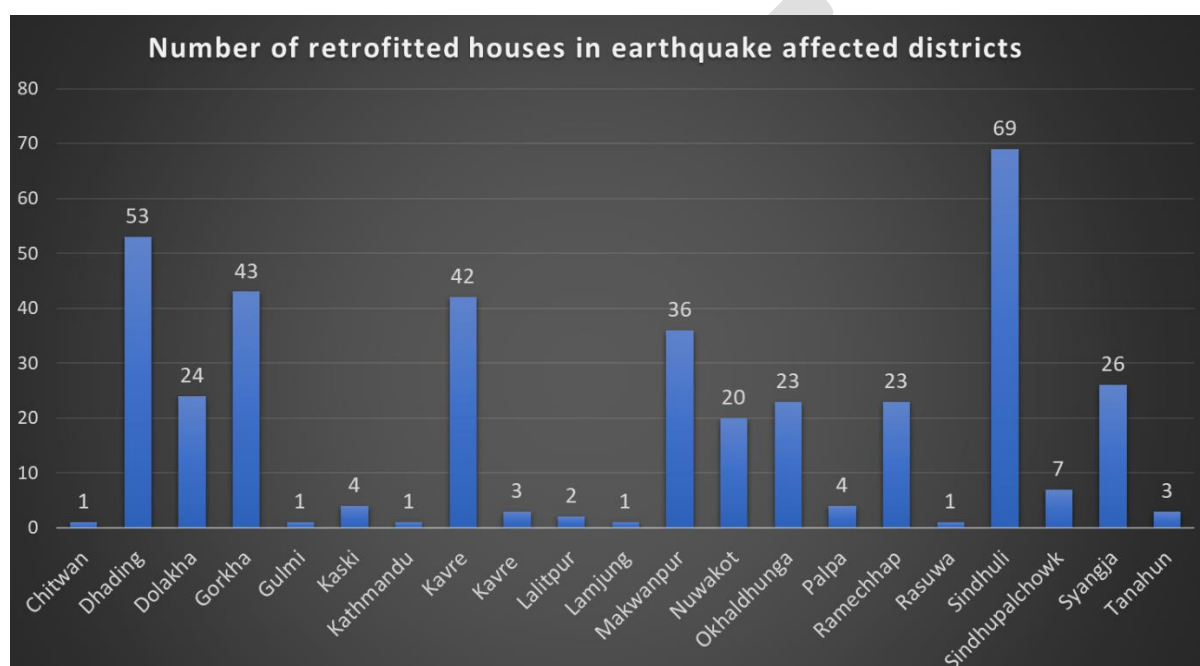

Out of those 387 houses, strong back technology (202) has been predominantly used, followed by splint and bandage technology (83). 67 timber buildings have also been supported for retrofitting, likewise containment reinforcement integrated splint and bandage technology was used to retrofit 30 houses.

Capacity building: Various methods and materials have been developed for capacity building of the technical personals on retrofitting that range from engineers, sub-engineers to the local masons and artisans. On-the-job trainings with combination of the practical and theoretical sessions were packaged for the training of the masons, while the engineers were trained through OJT, demonstration and classroom sessions.

Various partners have trained 816 NRA engineers, other engineers and sub-engineers. Number of these engineers trained in Makwanpur and Dhading districts were relatively higher than the other districts, which is followed by Ramechhap and Kavre districts. The roster of these engineers/sub-engineers are also annexed in this document.

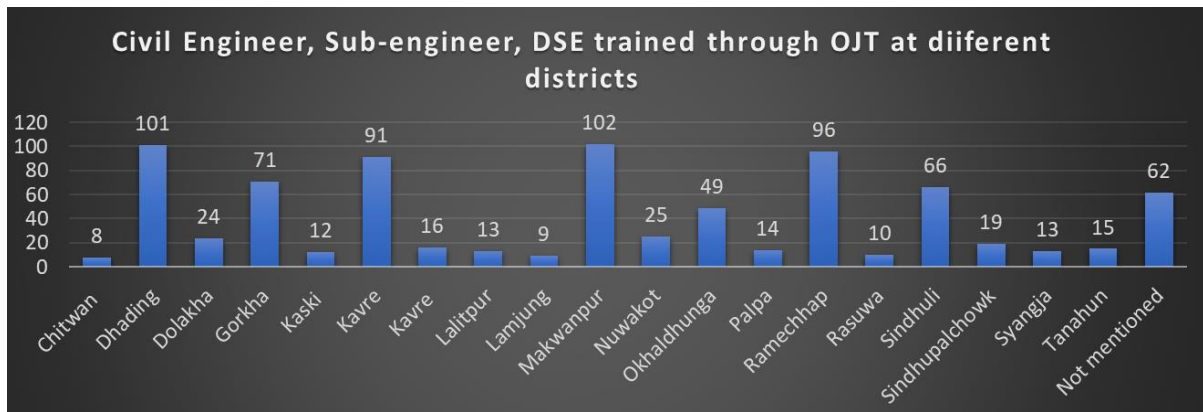

Likewise, 2,179 masons have been trained in 21 districts by the partners mostly through on-the-job trainings on a real site or a house. The number of masons trained in Gorkha are of higher number, followed by Dhading, Kavre and Sindhuli. The roster of these masons are also annexed in this document.

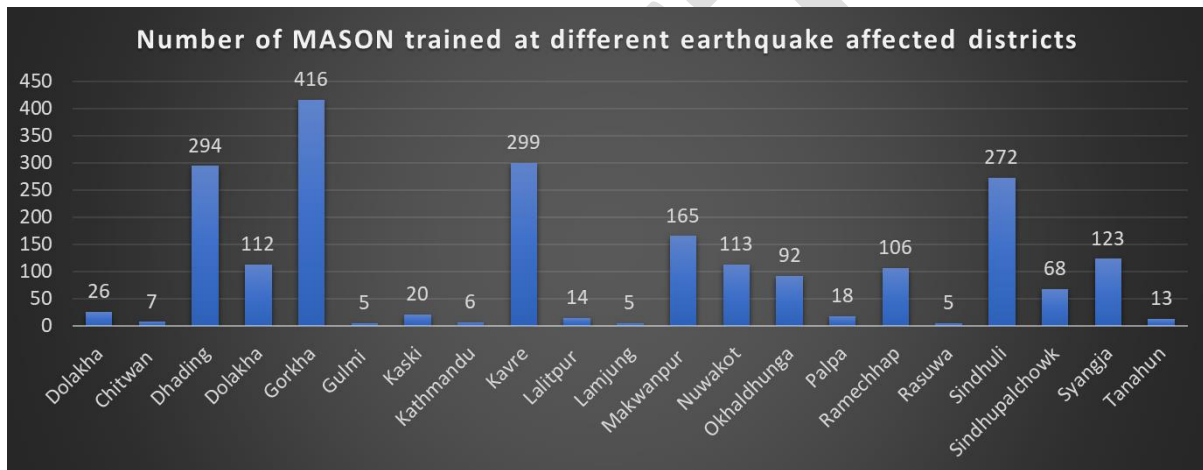

Study on Retrofitting in the Urban Areas

A total number of 77,325 retrofit beneficiaries are listed in NRA. Among them 24,083 number of beneficiaries are from urban areas, while the progress on retrofitting is very low. As of July 2020, only 158 houses from rural areas and 108 from urban areas have completed retrofitting. In Kathmandu Valley, a total number of 3,380 beneficiaries are listed as retrofitting beneficiaries. As of July 2020, only 15 number of retrofitting beneficiaries have completed retrofitting.

The

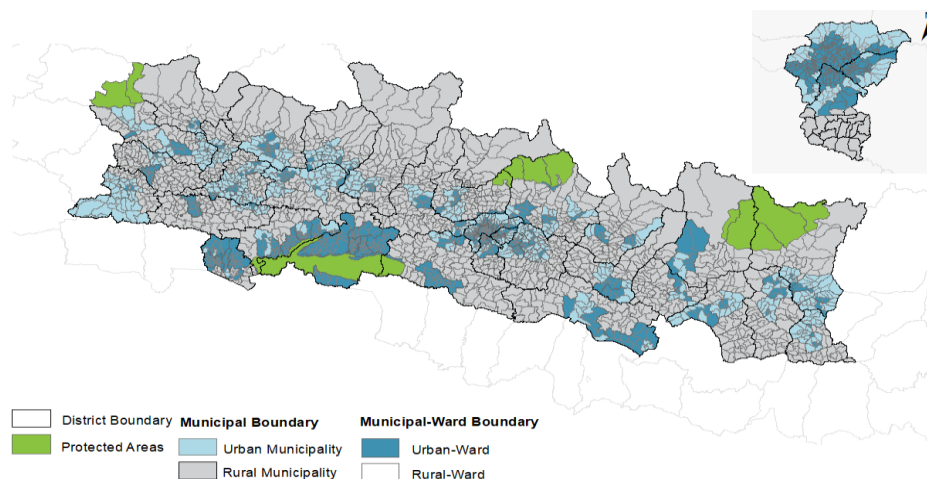

Map showing urban and rural wards. Inset: Urban wards concentration in Kathmandu Valley

progress of retrofitting has been summarized in the tables as:

Urban Status	Eligible	Enrolled	Completed	Remaining	Remaining %
Rural	43096	30267	158	42938	99.63%
Urban	25338	16966	106	25232	99.58%

The qualitative and quantitative approach

The Urban Recovery Technical Working Group (UR-TWG) with core members HRRP, CRS, Lumanti and NSET, with support from NRA & CLPIU Building, conducted a qualitative and quantitative assessment carried out from January to August 2020, on the identification, prioritization and analysis of urban housing recovery issues.

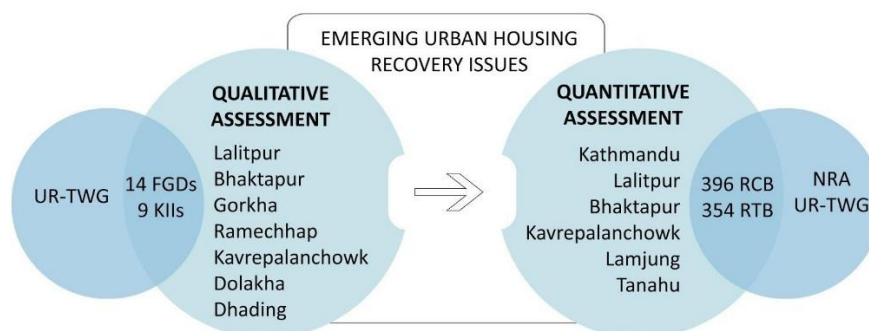

Figure 40: Development of qualitative and quantitative assessments with UR-TWG, NRA & CLPIU

Quantitative findings

Out of the houses enrolled in

Retrofitting more than half have repaired their houses and not actually retrofitted, 45% have not begun and 4% have started retrofitting. It has been found that 38% households are aware of the difference between repair and retrofitting, while 62% do not know the difference.

About 24% do not want to continue with the retrofitting, and 36% are awaiting transfer of their enrollment from retrofitting to reconstruction

The main reasons for households to transfer to reconstruction are that it is technically not possible to retrofit their houses (31%), they are not convinced with the technique (27%), and their houses have already been demolished (21%) and do not think retrofitting provides value for money (14%).

The biggest reasons to discontinue retrofitting is high cost (33%), the houses have been repaired instead of retrofitted (33%) and in some cases it is technically not feasible to retrofit (15%).

The survey found that 37% of retrofitting households have received technical assistance, and 63% are still to receive assistance. About 52% of the households are receiving assistance in the form of site supervision, 22% of design supervision, 14% have seen demo houses, and there is little support in the form of materials, labor, and finance.

(n= 818, RCB samples = 473, RTB samples = 345)

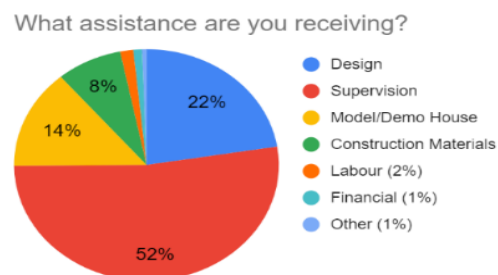
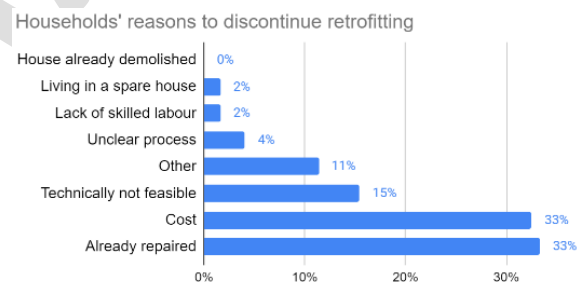
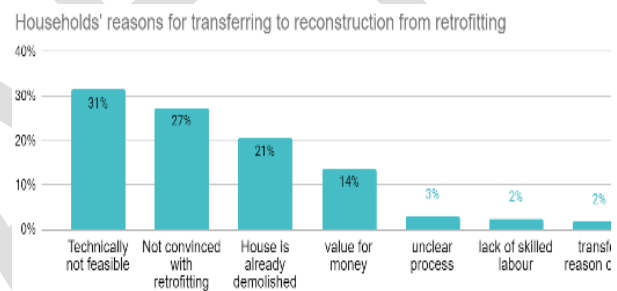
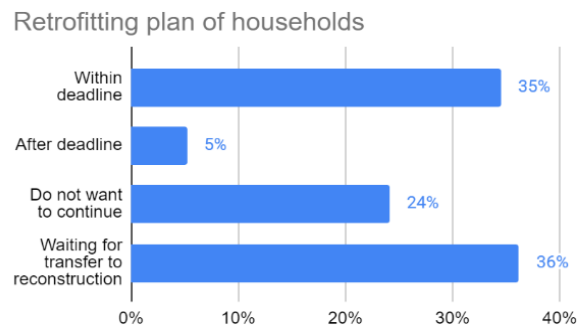
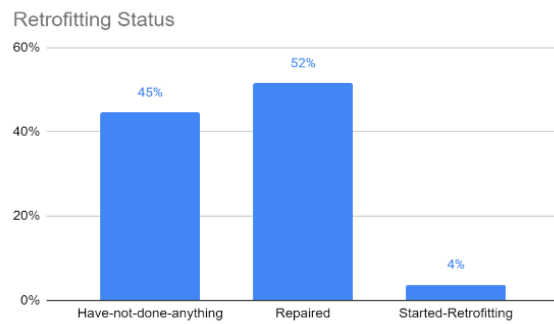

Quantitative findings : (14 Focused Group Discussion, 9 Key Informant Interview)

SN	Categories	Issues
1	Cost	<p>Cost is high depending on housing typology and other factors such as structural damage, house size and more.</p> <p>In urban areas, RCC buildings are dominant and the retrofitting cost of RCC structure may be higher as compared to other structures</p>
2	Technical manpower	<p>There is a huge lack of skilled masons and technical person expertise on retrofitting.</p> <p>Limited structural engineers to analyze and design unique retrofit solutions.</p> <p>Lack of appropriate and timely training and guidelines</p>
3	Awareness	<p>There is confusion between retrofit and repair among beneficiaries.</p> <p>There is no separate Socio-technical assistance for retrofitting.</p> <p>Lack of willingness among beneficiaries as they are not certain about the technology.</p> <p>Lack of usage of locally available materials</p>
4	Complexity	<p>In core areas of Kathmandu such as Sankhu, Indrachowk, etc. multiple storey load bearing structure in mud of more than 3 storey has been listed under retrofitting which seems not feasible for the retrofitting.</p> <p>Retrofitting of adjoined buildings is more complex and at times technically not feasible.</p> <p>No provision of multiple grants for multiple ownership of retrofit, so many of the house owners have not been able to retrofit their houses</p>
5	Compliance	<p>Traditional building requires to be complaint with building code, byelaws of the municipality and department of Archeology.</p> <p>Several house owners are willing to demolish and reconstruct a modern house.</p>

Challenges and learnings on retrofitting

Retrofitting is a new concept for many rural communities. Although some number of retrofitting of public buildings had been done before the earthquake, retrofitting had never been done in any scale in rural houses before the Nepal Gorkha earthquake. Even after the earthquake there were only a handful of organizations involved in retrofitting work. The major challenges that exist in implementing retrofitting programs and in moving retrofitting forward are as listed below:

Lack of viable technologies: There is lack of adequate research on the low-strength or non-engineered buildings in Nepal. Hence the retrofitting solutions are still evolving and not matured like the technical norms for new construction. There is a long way to go before we develop approaches, guidelines and implement, particularly considering sparse settlement, difficulty in access, displacement of local materials and skill, lack of confidence on retrofitting and lack of skilled human resources. Inherent weakness of masonry buildings to meet National Building Code requirements with minimal intervention and at affordable cost is challenging. Building codes are prepared for modern and strong materials and the attempt is to fit the standards in vernacular structure (paradox), which makes the technical solution not viable and affordable.

Lack of risk awareness and need of retrofitting: Due to lack of awareness and limited understanding of the risk, retrofitting is not prioritized by the house owner and even the local leaders, who should otherwise be providing incentives for undertaking forward retrofitting. Retrofitting requires resources hence without financial assistance or incentives in the initial phase to demonstrate, it is difficult for house owner to decide on investing their limited money on increasing safety rather than fulfilling other needs. Especially when spending all that money does not give them any additional living space.

Limited exposure on retrofitting of the public/beneficiaries making replication difficult: Retrofitting is a new and evolving concept and there are limited buildings that are retrofitted, making it difficult for the beneficiaries to visualize the entire process. Unlike reconstruction or new sites, the amount of ongoing retrofitting locations are very few in number that may not be able to reinforce the understanding of retrofitting, particularly where the impact of 2015 earthquake has been less. Even in areas impacted by earthquake, people have lost confidence on stone masonry building and with new RC technology introduced, it is difficult to convince them on possibility of retrofitting of their damaged masonry buildings.

Willingness of retrofitting beneficiaries to transfer into reconstruction beneficiaries: There are many reasons behind the willingness of retrofitting beneficiaries to transfer to the reconstruction. One of the pertinent reasons is the difference between amount of money provided for retrofitting vs reconstruction. i.e. they receive NPR 100,000 for retrofitting as compared to NPR 300,000 for rebuilding a new house. As a result, many beneficiaries are willing to transfer to reconstruction, not realizing that they would end up spending more with a much smaller house. It is also important to note that the unit cost of retrofitting is rather small, amounting up to 25 to 30% of new construction. However, the existing houses are usually large. Hence the total cost of preserving the traditional house and making it earthquake resilience is more than the allocated assistance of NPR 1,00,000.

Lack of adequate quality materials: Retrofitting of masonry buildings using GI wire mesh splint and bandage technique following the NRA Repair and Retrofit Manual is a plausible technique. However, wire meshes are not locally produced, and are not stocked by hardware vendors in large quantities. One such instance was seen in the immediate aftermath of the COVID-19 lockdown, where local producers in Birgunj were not able to produce due to a lack of raw materials. Although the issue was eventually resolved through direct market facilitation, a shortage of quality material could be foreseen if a large number of retrofit beneficiaries plan to retrofit their house. A market link and bridging the supply-demand gap is an area that needs to be addressed to support retrofitting at larger scale and on people's own initiative.

Lack of potential human resources/construction workforce to cater retrofitting needs: Retrofitting is a technical process that require discretion and calculated decision are taken while designing and implementation. The design and implementation process requires skilled workforce who have experience on the similar process before. There is lack of skilled human resources like engineers and

masons, who have knowledge and skill on retrofitting, thus making it difficult for the house owners to undertake retrofitting even if they are willing to. Building confidence among the engineers and stakeholders is critical, which comes from evidences and hands-on experiences.

Very few reconstruction implementing partners interested to include retrofitting in their agenda:

Where there were hundreds of organizations working on helping people reconstruct their houses, only a handful of them had retrofitting in their agenda. The consequence of this is that there are uncountable resources for new construction but very limited technical and non-technical resources for retrofitting. Awareness materials and resources at the local levels were limited to the efforts of only these handful of organizations.

Way forward:

Retrofitting Approach

Earthquake risk is the major threats to the safety of the population, investments and the economy. So, risk mitigation and reduction becomes essential. In other countries, retrofitting policies have been strongly promoted to improve the performance of the building stock as safer buildings decrease the risk of death and economic loss. Partial and incremental retrofitting is nowadays commonly accepted since it allows flexibility in reducing risk, especially when resources are limited. This approach addresses basic vulnerability thus ensuring life safety, to enhance the capacity of the buildings to resist seismic forces, where the steps to improve seismic resilience are spread over a period of time, based on the resource availability of the house owners. Incremental approach allows the individuals the liberty to decide how much he/she wants to spend at a particular time and also guarantees a homogeneous distribution of the interventions over the building stocks. Studies show every dollar in retrofitting pays back more than four times over the lifespan of unreinforced stone masonry buildings in Nepal. Typically, it has been observed that if people will take a step in the right direction today, however small, they are likely to take another step in future. But if nothing is done to reduce the vulnerability today, then nothing is likely to get done in future. So incremental retrofitting should be promoted to provide opportunity for the house owners to reduce their risk and increase life safety.

There are several houses still standing with minor cracks and used for various purpose, while owners have rebuilt a new one. We have the urgent need and opportunity to retrofit these damaged houses. Likewise, there are more than a million such houses outside the quake-hit areas that are substandard and need to be retrofitted using current learnings, as they are straddling over seismically active regions, which may shake anytime.

Public facilities and government buildings often provide lead in acceptance of any new technique. Selecting appropriately scaled Palika/ward buildings, health centres, schools or other such public buildings and retrofitting them will pave way for larger acceptance as well as provide examples at easily accessible places for people to observe retrofitting examples.

Selection of appropriate techniques and materials

The retrofitting technologies have to be tested and vetted by the experts, while the technology should be easily adaptable, replicable and economically viable. There have been several researches and studies on the retrofitting of masonry buildings using various techniques and materials. However, during the implementation of the trainings, it was learnt that selection of appropriate techniques and materials, owing to a number of factors including the building typology, cost of materials and its transportation and the economic status of the beneficiary is very important. As such, the splint and bandage technique using welded GI wire mesh was implemented during these pilot trainings as the cost of retrofitting using this technique and material was found to be most cost effective during comparative estimation. However, as this technique requires that the mesh be covered with plaster, communities without access to roads and where sand is not locally available are not attracted towards the technique. In other places which have good access, house owners, masons and local representatives have provided positive response towards the technique.

Comprehensive awareness campaign is necessary

Helping people to understand the risk and further building their confidence on retrofitting is essential to help them understand its need to reduce risk to life and property. In Nepal, where priority of the people is on fulfilling basic necessities, it is a challenge to convince people to retrofit their houses who may not see any short-term benefit. Hence, risk communication in house-owner's language for buy-in the need of retrofitting that is sensitive to the socio-economic dimension is essential in building confidence of the people to take actions.

The retrofitting should be practical, using local materials, affordable, easier to understand and replicate, with flexibility of staggered investments, through incremental approach of seismic strengthening. Hence, integrated and comprehensive social awareness campaigns need to be conducted in the areas, with orientation programs, video demonstration, door to door campaigns, and audio visual medium and coordination and orientation meetings with elected representatives, participation of elected representatives in district and national workshops and conferences, etc. so as to create an atmosphere of positivity towards retrofitting. The sensitization and orientation programs need to focus on the increased safety, technical aspects, cost comparison between retrofitting a large existing house versus building a new house of the same size, retaining the lifestyle as well as cultural values, etc. In other words, people should have clarity on relationship between the outcome of retrofitting, cost of retrofitting and cost of new construction to enable people to make a right choice.

Sensitization and building ownership of the stakeholders

Representatives and the local authorities are the influential leaders in the society. While the NRA promulgated and published the manual on repair and retrofitting of masonry buildings in June 2017, the implementation of the provisions and techniques has not progressed. This delay can, in some part, be attributed to the fact that retrofitting, being a relatively new concept to almost all stakeholders, including elected leaders, policy makers, and technical personnel. Hence, in conjunction with the masons training, exposure visit and retrofit demonstration to the policy makers and the local level authorities will help to enhance the common understanding on retrofitting among all stakeholders.

Build guild of local masons trained through OJT

It is obligatory that technical personnel gain the required knowledge, skill and expertise in retrofitting so as to increase their confidence in providing technical support to the house owners. Both Engineers and Local masons with on-the job training (OJT) have been able to perform well. Once the masons work in one house, from foundation to the roof, they can understand the concept and learn all the integral aspects of retrofitting and can undertake retrofitting with minimum technical support from engineers. In terms of designing the elements the engineers may need to help but in terms of implementation, local masons can better work once they go through on the job trainings.

Improve supply chain and assure quality of the construction materials

The supply of appropriate materials and tools for retrofitting needs to be addressed by working with construction material suppliers in the local market. A supply link needs to be established for such materials. Along with awareness on retrofitting, which will generate demand, a sustainable and affordable supply chain needs to be facilitated in coordination with building material suppliers and local vendors. The market and social aspect of retrofitting will form a holistic package for wider dissemination and acceptance of retrofitting of the existing buildings.

Retrofitting to be included in engineering and vocational training curriculums:

For engineers to be confident in providing advice on retrofitting, it should be a part of the mainstream civil engineering course curriculum in universities, which is currently not the case. Also, institutions such as the Council of Technical Education and Vocational Trainings should include the retrofitting mason training curriculums that were developed into their mainstream mason training curriculums.

Annex 1: List of Retrofit Resources Available for Public Use

A collection of digital files for the retrofit resources were collected and are made available in the following link:

<https://drive.google.com/drive/folders/0ANBjKIKKdlbwUk9PVA>

The list of documents available for public use are tabulated as follows:

Document Title	Organization	Type of Document	Description	Who can use it
Case Study: Baldam Bahadur Pulami, Resident - Tinpatan, Sindhuli	UNOPS	Case Study	Homeowners experience on retrofitting their house	Anyone
Mr. Bal Bahadur Lama, Resident - Khadadevi, Ramechhap	UNOPS	Case Study	Homeowners experience on retrofitting their house	Anyone
Balasari Rai, Municipal Council Member, Siddhicharan, Okhaldhunga	UNOPS	Case Study	Municipal Members experience on retrofitting their house	Anyone
Bir Bahadur Thapa, Ward Chair - Siranchowk, Gorkha	UNOPS	Case Study	Ward Chair's experience on retrofitting their house	Anyone
Dil Maya B.K., Mason - Syangja	UNOPS	Case Study	Masons experience on retrofitting their house	Anyone
Hasta Tamang, Resident - Ramechhap	UNOPS	Case Study	Homeowners experience on retrofitting their house	Anyone
Janak Bahadur Bishwokarma, Resident - Okhaldhunga	UNOPS	Case Study	Homeowners experience on retrofitting their house	Anyone
Jogmaya Tamang, Mason - Kavre	UNOPS	Case Study	Masons experience on retrofitting their house	Anyone
Kamal Kant Regmi, Resident - Syangja	UNOPS	Case Study	Homeowners experience on retrofitting their house	Anyone
Kiranman Bal - Makwanpur	UNOPS	Case Study	Homeowners experience on retrofitting their house	Anyone
Krishna Kumar Khatri - Dolakha	UNOPS	Case Study	Homeowners experience on retrofitting their house	Anyone
Mithu Maya Lama	UNOPS	Case Study	Builders experience on retrofitting their house	Anyone
Sanilal Adhikari - Sindhuli	UNOPS	Case Study	Homeowners experience on retrofitting their house	Anyone

Teknath Baral - Pokhara	UNOPS	Case Study	Homeowners experience on retrofitting their house	Anyone
Benefits of retrofitting	UNOPS	IEC Materials	Video showing the benefits of retrofitting	Anyone
How retrofitting is done	UNOPS	IEC Materials	Video showing how retrofitting is done	Anyone
What is retrofitting	UNOPS	IEC Materials	Video showing what retrofitting is	Anyone
Whom to meet to retrofit the house	UNOPS	IEC Materials	Video showing how to initiate retrofitting process	Anyone
Why retrofitting	UNOPS	IEC Materials	Video showing benefits of retrofitting	Anyone
Shyam Bahaur Lama - Bhimphedi	UNOPS	IEC Materials	Video showing benefits of retrofitting	Anyone
Call for Code - Artificial Intelligence for Retrofitting	UNOPS	IEC Materials	Video showing how Artificial Intelligence can be used for retrofitting design and drawing	Anyone
Retrofitting Short Film - Kavre	UNOPS	IEC Materials	Video showing benefits of retrofitting	Anyone
Retrofitting awareness video	UNOPS	IEC Materials	Video showing benefits of retrofitting	Anyone
Splint and Bandage retrofitting video	UNOPS	IEC Materials	Video showing benefits of retrofitting	Anyone
Usha didi retrofitting awareness video	UNOPS	IEC Materials	Video showing benefits of retrofitting	Anyone
Typical Strong back retrofit design	UNOPS	Retrofit Technical Documents	Retrofit Design drawings for a house with strong back technology	Engineer
Typical splint and bandage retrofit design	UNOPS	Retrofit Technical Documents	Retrofit Design drawings for a house with splint and bandage technology	Engineer
Typical timber house retrofit design	UNOPS	Retrofit Technical Documents	Retrofit Design drawings for a timber house	Engineer
Typical timber house with masonry ground floor retrofit design	UNOPS	Retrofit Technical Documents	Retrofit Design drawings for a timber house with masonry skirt	Engineer
Typical open front house retrofit design	UNOPS	Retrofit Technical Documents	Retrofit Design drawings for an open front SMM house	Engineer

Typical dry stone retrofit design	UNOPS	Retrofit Technical Documents	Retrofit Design drawings for a dry stone masonry stone house	Engineer
Rural house retrofitting training for Builders	UNOPS	Retrofit Technical Documents	On the Job training manual for builders on SMM house retrofitting using strong back approach	Builder trainers/ engineers
SMM house retrofitting Manual using Strong back approach	UNOPS	Retrofit Technical Documents	Manual for designing retrofit for SMM houses using strong back approach	Engineer
Picture guide for retrofit an SMM house with Strong back approach	UNOPS	Retrofit Technical Documents	Pictorial guide showing construction steps for retrofitting SMM houses with strong back approach	Builders, engineers
Seismic resistant Construction and retrofit of dry stone masonry houses	Build Change	Retrofit Technical Documents	Technical paper of retrofitting of dry stone masonry houses	Engineers
Nonlinear analysis of tradition SMM houses in Nepal before and after retrofitting	Build Change	Retrofit Technical Documents	Technical paper on non linear analysis of SMM houses]	Engineers
Calibrating a constitutive nonlinear material model for SMM walls in Nepal	Build Change	Retrofit Technical Documents	Technical paper on establishing non-linear material model for SMM walls	Engineers
Seismic retrofitting of traditional SMM houses in rural Nepal	Build Change	Retrofit Technical Documents	Technical paper on seismic retrofitting of SMM houses	Engineers
Comparison of retrofitting approaches in Nepal	Build Change	Retrofit Technical Documents	Study comparing strong back approach and splint and bandage approach for retrofitting SMM houses	Engineers
Repair and restoration awareness flyer	UNDP	IEC Materials	Public awareness on repair and restoration	Anyone
Retrofitting awareness flyer	UNDP	IEC Materials	Public awareness on retrofitting	Anyone
Field guide for repair and retrofitting for engineers	UNDP	Retrofit Technical Documents	Visual technical guideline for repair and retrofitting for the engineers	Engineers
Masons field guide for seismic retrofitting	UNDP	Retrofit Technical Documents	Visual technical guideline for repair and retrofitting for the masons	Masons

Repair and Restoration Booklet	UNDP	IEC Materials	Guideline for repair and restoration of damaged house	Anyone
Posters on Retrofitting for public awareness	UNDP	IEC Materials	6 - set posters on step by step retrofitting of SMM house	Masons and Engineers
Towards safer life	UNDP	IEC Materials	Video on awareness on retrofitting	Anyone
Retrofitting brings safety - seeing is believing	UNDP	IEC Materials	Video on awareness on retrofitting - shock table demonstration	Anyone
Casestory Restoring Ancestral home	UNDP	Case Study	Home owners experience of retrofitting	Anyone
Casestory Mason training bringing hope	UNDP	Case Study	Masons experience of training on retrofitting	Anyone
CR Integrated Splint and Bandage technology	UNDP	Retrofit Technical Documents	Drawings and pictures of 2.5 storey house retrofitting using CR integrated splint and bandage	Engineers
Step by Step 3D of CR integrated Splint and Bandage	UNDP	Retrofit Technical Documents	3D step by step snapshot of 2 storey house retrofitting using CR integrated splint and bandage	Engineers and masons
Splint and bandage_1 storey	UNDP	Retrofit Technical Documents	Drawings of 1 storey house retrofitting using splint and bandage	Engineers
IMPROVING SEISMIC SAFETY OF EXISTING VERNACULAR BUILDINGS	UNDP	Retrofit Technical Documents	Scientific paper - publication - incremental approach in retrofitting	Engineers
Case Stories_Retrofitting_hoouse owner, LG, masons	NSET	Case Study	Compilation of 4 case stories	Anyone
Handbook_Retrofit 10 Key Points	NSET	IEC Materials	10 key points to remember for retrofitting	Anyone
10 key points for retrofitting	NSET	IEC Materials	Poster for public awareness	Anyone
Retrofitting cost comparison	NSET	IEC Materials	Poster for public awareness on cost of retrofitting	Anyone
Orientation on Retrofitting_Video	NSET	IEC Materials	Video on public awareness - retrofitting	Anyone
Way forward in retrofitting	NSET	Lessons Learnt	Challenges and major learnings - notes	Policy makers

Retrofit Mason Training 25 days Curricula	NSET	Retrofit Technical Documents	Training curriculum for Masons for retrofitting using splint and bandage construction	Trainers
Retrofit Engineers Training 4 days Curricula	NSET	Retrofit Technical Documents	Training curriculum for Engineers for retrofitting using splint and bandage approach	Engineers/ Trainers

DRAFT

DRAFT